

P4R
electronics



9203

**Solenoid /
alarm driver**

No. 9203V105-UK
Product version: 9203-003



ATEX  CCOE  

- DK** ▶ PR electronics A/S tilbyder et bredt program af analoge og digitale signalbehandlingsmoduler til industriel automation. Programmet består af Isolatorer, Displays, Ex-barrierer, Temperaturtransmittere, Universaltransmittere mfl. Vi har modulerne, du kan stole på i selv barske miljøer med elektrisk støj, vibrationer og temperaturudsving, og alle produkter opfylder de strengeste internationale standarder. Vores motto »Signals the Best« er indbegrebet af denne filosofi - og din garanti for kvalitet.
- UK** ▶ PR electronics A/S offers a wide range of analog and digital signal conditioning devices for industrial automation. The product range includes Isolators, Displays, Ex Interfaces, Temperature Transmitters, and Universal Devices. You can trust our products in the most extreme environments with electrical noise, vibrations and temperature fluctuations, and all products comply with the most exacting international standards. »Signals the Best« is the epitome of our philosophy - and your guarantee for quality.
- FR** ▶ PR electronics A/S offre une large gamme de produits pour le traitement des signaux analogiques et numériques dans tous les domaines industriels. La gamme de produits s'étend des transmetteurs de température aux afficheurs, des isolateurs aux interfaces SI, jusqu'aux modules universels. Vous pouvez compter sur nos produits même dans les conditions d'utilisation sévères, p.ex. bruit électrique, vibrations et fluctuations de température. Tous nos produits sont conformes aux normes internationales les plus strictes. Notre devise »SIGNALS the BEST« c'est notre ligne de conduite - et pour vous l'assurance de la meilleure qualité.
- DE** ▶ PR electronics A/S verfügt über ein breites Produktprogramm an analogen und digitalen Signalverarbeitungsgeräte für die industrielle Automatisierung. Dieses Programm umfasst Displays, Temperaturtransmitter, Ex- und galvanische Signaltrenner, und Universalgeräte. Sie können unsere Geräte auch unter extremen Einsatzbedingungen wie elektrisches Rauschen, Erschütterungen und Temperaturschwingungen vertrauen, und alle Produkte von PR electronics werden in Übereinstimmung mit den strengsten internationalen Normen produziert. »Signals the Best« ist Ihre Garantie für Qualität!

SOLENOID / ALARM DRIVER

9203

CONTENTS

| | |
|--|----|
| Warning..... | 2 |
| Symbol identification | 2 |
| Safety instructions..... | 2 |
| How to demount system 9000 | 4 |
| Advanced features | 5 |
| Application..... | 5 |
| Technical characteristics..... | 6 |
| Applications - 9203Axxx..... | 7 |
| Applications - 9203Bxxx..... | 8 |
| PR 4501 Display / programming front..... | 9 |
| Mounting / demounting the PR 4501/4511..... | 10 |
| Order: 9203..... | 11 |
| Accessories | 11 |
| Electrical specifications..... | 11 |
| Visualisation in 4501 of hardware / software error | 16 |
| Connections | 17 |
| Block diagram..... | 20 |
| Signal error indications without display front | 21 |
| Configuration / operating the function keys..... | 21 |
| Routing diagram..... | 23 |
| Routing diagram, Advanced settings (ADV.SET)..... | 24 |
| Scrolling help texts in display line 3..... | 25 |
| Appendix | 26 |
| IECEX Installation Drawing..... | 27 |
| ATEX Installation Drawing..... | 31 |
| FM Installation Drawing | 35 |
| INMETRO Installation Drawing | 38 |
| Safety Manual..... | 42 |



WARNING

The following operations should only be carried out on a disconnected device and under ESD-safe conditions:

- General mounting, connection and disconnection of wires.
- Troubleshooting the device.

Repair of the device and replacement of circuit breakers must be done by PR electronics A/S only.



WARNING

Do not open the front plate of the device as this will cause damage to the connector for the display / programming front PR 4501. This device contains no DIP-switches or jumpers.

SYMBOL IDENTIFICATION



Triangle with an exclamation mark: Read the manual before installation and commissioning of the device in order to avoid incidents that could lead to personal injury or mechanical damage.



The CE mark proves the compliance of the device with the essential requirements of the directives.



The double insulation symbol shows that the device is protected by double or reinforced insulation.



Ex devices have been approved according to the ATEX directive for use in connection with installations in explosive areas. See installation drawings in appendix.

SAFETY INSTRUCTIONS

DEFINITIONS

Hazardous voltages have been defined as the ranges: 75...1500 Volt DC, and 50...1000 Volt AC.

Technicians are qualified persons educated or trained to mount, operate, and also troubleshoot technically correct and in accordance with safety regulations.

Operators, being familiar with the contents of this manual, adjust and operate the knobs or potentiometers during normal operation.

RECEIPT AND UNPACKING

Unpack the device without damaging it and check whether the device type corresponds to the one ordered. The packing should always follow the device until this has been permanently mounted.

ENVIRONMENT

Avoid direct sunlight, dust, high temperatures, mechanical vibrations and shock, as well as rain and heavy moisture. If necessary, heating in excess of the stated limits for ambient temperatures should be avoided by way of ventilation.

The device must be installed in pollution degree 2 or better.

The device is designed to be safe at least under an altitude up to 2 000 m.

MOUNTING

Only technicians who are familiar with the technical terms, warnings, and instructions in the manual and who are able to follow these should connect the device.

Should there be any doubt as to the correct handling of the device, please contact your local distributor or, alternatively,

PR electronics A/S
www.prelectronics.com

The use of stranded wires is not permitted for mains wiring except when wires are fitted with cable ends.

Descriptions of input / output and supply connections are shown in the block diagram and on the side label.

The device is provided with field wiring terminals and shall be supplied from a Power Supply having double / reinforced insulation. A power switch shall be easily accessible and close to the device. The power switch shall be marked as the disconnecting unit for the device.

For installation on Power Rail 9400 the power is supplied by Power Control Unit 9410.

Year of manufacture can be taken from the first two digits in the serial number.

CALIBRATION AND ADJUSTMENT

During calibration and adjustment, the measuring and connection of external voltages must be carried out according to the specifications of this manual. The technician must use tools and instruments that are safe to use.

NORMAL OPERATION

Operators are only allowed to adjust and operate devices that are safely fixed in panels, etc., thus avoiding the danger of personal injury and damage. This means there is no electrical shock hazard, and the device is easily accessible.

CLEANING

When disconnected, the device may be cleaned with a cloth moistened with distilled water.

LIABILITY

To the extent that the instructions in this manual are not strictly observed, the customer cannot advance a demand against PR electronics A/S that would otherwise exist according to the concluded sales agreement.

HOW TO DEMOUNT SYSTEM 9000

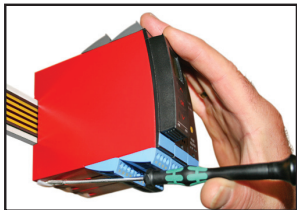

Picture 1:

By lifting the bottom lock, the device is detached from the DIN rail.

SOLENOID / ALARM DRIVER 9203

- *Universal driver for solenoids, acoustic alarms and LEDs*
- *Extended self-diagnostics*
- *1 or 2 channels*
- *Can be supplied separately or installed on power rail, PR 9400*
- *SIL 2-certified via Full Assessment*

Advanced features

- The 9203Bxxx features three built-in Ex barriers.
- Two hardware versions make it possible to choose either Low (35 mA) or High (60 mA) current output.
- Configuration and monitoring by way of detachable display front (PR 4501).
- Selection of direct or inverted function for each channel via PR 4501 and the possibility of reducing the output current to the hazardous area to suit the application.
- Optional monitoring of the output current to the hazardous area by way of PR 4501.
- Optional redundant supply via power rail and/or separate supply.

Application

- The 9203Bxxx can be mounted in the safe area or in zone 2 / div. 2 and transmit signals to zone 0, 1, 2 and zone 20, 21, 22 including M1 mining / Class I/II/III, Div. 1, Gr. A-G. Ex driver for the control of ON / OFF solenoids, acoustic alarms and LEDs mounted in the hazardous area.
- The 9203Axxx can be mounted in the safe area or zone 2 / div. 2 and transmit signals to non-hazardous area. Driver for the control of ON / OFF solenoids, acoustic alarms and LEDs mounted in safe area.

- Monitoring of internal error events via the individual status relay and/or a collective electronic signal via the power rail.
- The 9203 has been designed, developed and certified for use in SIL 2 applications according to the requirements of IEC 61508.

Technical characteristics

- 1 green and 2 yellow/red front LEDs indicate operation status and malfunction.
- 2.6 kVAC galvanic isolation between input, output and supply.

APPLICATIONS - 9203Axxx

Output signals:

Input signals:

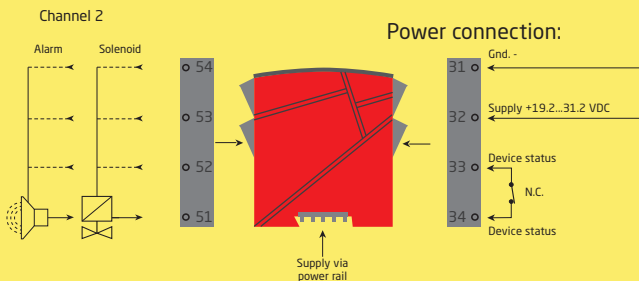
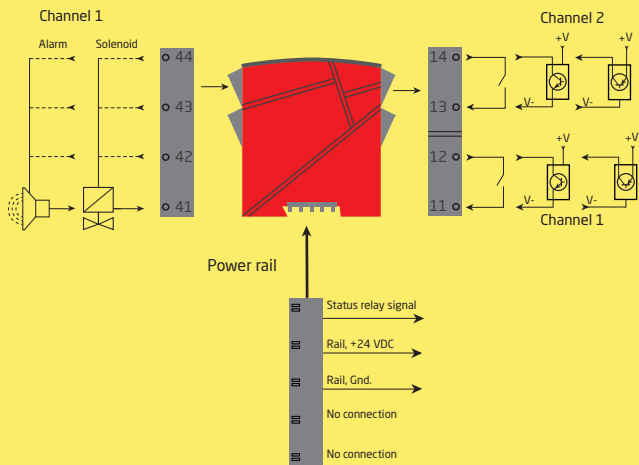

Zone 2 / Cl. 1, div. 2, gr. A-D or safe area

APPLICATIONS - 9203Bxxx

Output signals:

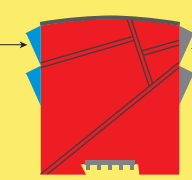
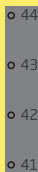

Input signals:

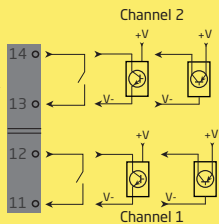

Power rail

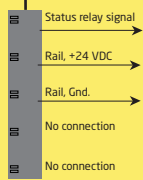

Channel 2

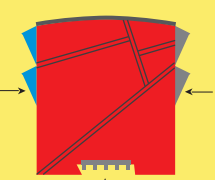
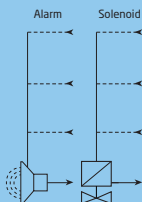

Power connection:

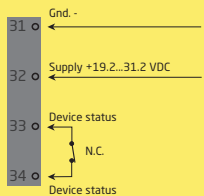

Supply via power rail

**Zone 0, 1, 2,
20, 21, 22, M1 &
Cl. I/II/III, div. 1
gr. A-G**

Zone 2 / Cl. 1, div. 2, gr. A-D or safe area

PR 4501 DISPLAY / PROGRAMMING FRONT



Functionality

The simple and easily understandable menu structure and the explanatory help texts guide you effortlessly and automatically through the configuration steps, thus making the product very easy to use. Functions and configuration options are described in the section "Configuration / operating the function keys".

Application

- Communications interface for modification of operational parameters in 9203.
- When mounted in the process, the display shows process values and device status.

Technical characteristics

- LCD display with 4 lines; Line 1 (H=5.57 mm) shows status for each channel (OK or error). Line 2 (H=3.33 mm) shows output for channel 1 (ON / OFF), line 3 (H=3.33 mm) shows output for channel 2 (ON / OFF), and line 4 shows whether the device is SIL-locked. Static dot = SIL-locked and flashing dot = not SIL-locked. Line 4 also indicates if the output is active.
- In order to protect the configuration against unauthorised changes, access to the menus can be blocked by a password.

MOUNTING / DEMOUNTING THE PR 4501/4511

1: Insert the taps of 4501/4511 into the holes at the top of the device.

2: Swing 4501/4511 into place.

Demounting of 4501/4511

3: Push the release button on the bottom of 4501/4511 and swing 4501/4511 up.

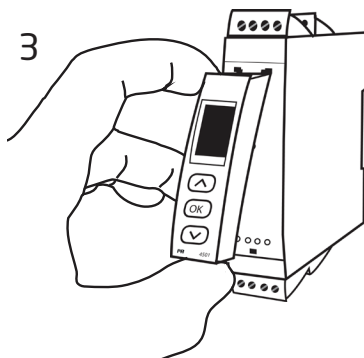
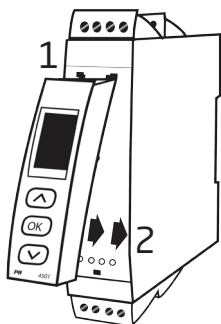

Order: 9203



| Type | Version | Output | Channels | Input |
|------|--------------------------------------|---------------------|----------------------|-------------------|
| 9203 | Non-Ex / zone 2... : A | Low current ... : 1 | Single : A | Standard..... : - |
| | Ex barrier [Ex ia] / zone 2..... : B | | Double : B | PNP : 1 |
| | | | High current ... : 2 | Single : A |

Accessories

| Type | Description |
|-------------|------------------------------------|
| 4501 | Display / programming front |
| 4511 | Communication enabler |
| 9400 | Power rail |
| 9404 | Module stop for rail |
| 9410 | Power control unit |
| 9420 | Power supply 24 V / 120 W - Ex nAC |

Electrical specifications

Environmental conditions

| | |
|-------------------------------|--|
| Specifications range..... | -20...+60°C |
| Storage temperature | -20...+85°C |
| Calibration temperature | 20...28°C |
| Relative humidity..... | < 95% RH (non-cond.) |
| Protection degree..... | IP20 |
| Installation in..... | Pollution degree 2 & measurement / overvoltage category II |

Mechanical specifications:

| | |
|---|--|
| Dimensions (HxWxD)..... | 109 x 23.5 x 104 mm |
| Dimensions (HxWxD) w/ 4501 / 4511 | 109 x 23.5 x 116 / 131 mm |
| Weight approx..... | 170 g |
| Weight incl. 4501 / 4511 (approx.)..... | 185 g / 270 g |
| DIN rail type..... | DIN EN 60715 / 35 mm |
| Wire size | 0.13...2.08 mm ² AWG 26...14 stranded wire |
| Screw terminal torque | 0.5 Nm |
| Vibration..... | IEC 60068-2-6 : 2007 |
| 2...13.2 Hz..... | ±1 mm |
| 13.2...100 Hz | ±0.7 g |

Common specifications:

| | |
|--------------------------------------|---|
| Supply voltage..... | 19.2...31.2 VDC |
| Max. consumption..... | ≤ 3.5 W (2 channels) |
| Fuse..... | 1.25 A SB / 250 VAC |
| Isolation voltage, test / operation: | |
| Input / output / supply | 2.6 kVAC / 250 VAC |
| Output 1 to output 2..... | 1.5 kVAC / 150 VAC reinforced |
| Status relay to supply | 1.5 kVAC / 150 VAC reinforced |
| Communications interface | Communication enabler 4511 / Programming front 4501 |

| | |
|---------------------------------------|-----------------|
| EMC immunity influence | < ±0.5% of span |
| Extended EMC immunity: | |
| NAMUR NE 21, A criterion, burst | < ±1% of span |

9203xxx NPN open collector and mechanical switch:

| | |
|-----------------------------|-----------|
| Trig level LOW | ≤ 2.0 VDC |
| Trig level HIGH | ≥ 4.0 VDC |
| Max. external voltage | 28 VDC |
| Input impedance | 3.5 kΩ |
| V open input..... | 6.0 VDC |

9203xxx PNP open collector:

| | |
|-----------------------------|------------|
| Trig level LOW | ≤ 8.0 VDC |
| Trig level HIGH..... | ≥ 10.0 VDC |
| Max. external voltage | 28 VDC |
| Input impedance | 3.5 kΩ |
| V open input..... | 6.0 VDC |

9203xxx1 PNP with pull-down resistor:

| | |
|---------------------------|------------|
| Trig level low | ≤ 8.0 VDC |
| Trig level high | ≥ 10.0 VDC |
| Max external voltage..... | 28 VDC |
| Input impedance | 3.5 kΩ |

9203xxx2 NPN with pull-up resistor:

| | |
|---------------------------|-----------|
| Trig level low | ≤ 2.0 VDC |
| Trig level high | ≥ 4.0 VDC |
| Max external voltage..... | 28 VDC |
| Input impedance | 3.5 kΩ |

Outputs:

| | |
|---------------------|-------------|
| Output ripple | < 40 mV RMS |
|---------------------|-------------|

Output loads

| Terminal | 9203x1Ax (1 channel) / 9203x1Bx (2 channels) | | |
|-----------------|--|---------------|---------------|
| | 41-42 / 51-52 | 41-43 / 51-53 | 41-44 / 51-54 |
| Vout. no load | Min. 24 V | Min. 24 V | Min. 24 V |
| Vout. with load | Min. 12.5 V | Min. 13.5 V | Min. 14.5 V |
| Iout. max | 35 mA | 35 mA | 35 mA |

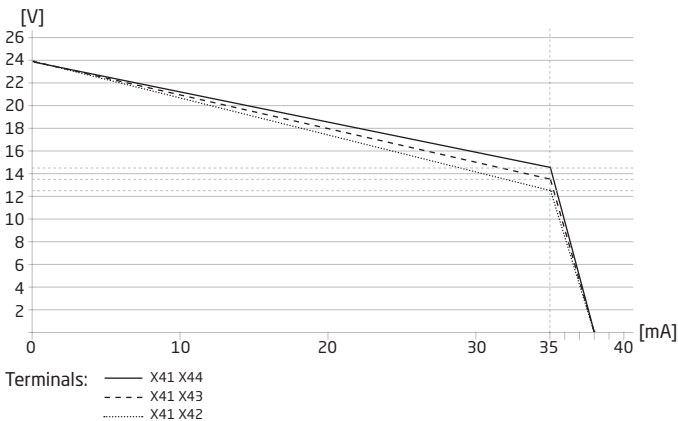

| Terminal | 9203x2Ax (1 channel) | | | | | |
|-----------------|----------------------|----------|-------------|-----------|-------------|-----------|
| | 41-42 | | 41-43 | | 41-44 | |
| Vout. no load | Min. 24 V | | Min. 24 V | | Min. 24 V | |
| Vout. with load | Min. 11.5 V | Min. 9 V | Min. 12.5 V | Min. 10 V | Min. 13.5 V | Min. 11 V |
| Iout. max | 50 mA | 60 mA | 50 mA | 60 mA | 50 mA | 60 mA |

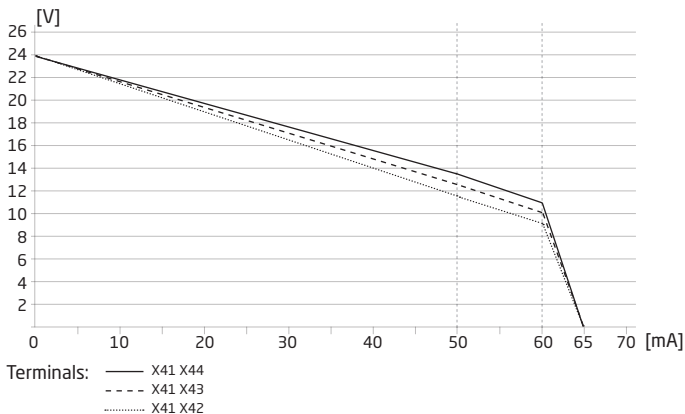

Relay output:

Status relay in safe area:

| | |
|-------------------|---------------------|
| Max. voltage..... | 125 VAC / 110 VDC |
| Max. current..... | 0.5 A AC / 0.3 A DC |
| Max. power..... | 62.5 VA / 32 W |

Approvals:

| | |
|------------------------------------|-------------------------|
| EMC 2004/108/EC..... | EN 61326-1 |
| LVD 2006/95/EC..... | EN 61010-1 |
| c UL us, Standard for Safety..... | UL 61010-1 |
| EAC TR-CU 020/2011..... | EN 61326-1 |
| Metrological Pattern Approval..... | DK.C.34.004.A No. 47954 |

Marine:

| | |
|---|-----------------------------|
| Det Norske Veritas, Ships & Offshore..... | Stand. f. Certific. No. 2.4 |
|---|-----------------------------|

I.S. / Ex:

| | |
|----------------------------|----------------------|
| ATEX 94/9/EC..... | KEMA 07ATEX0147 X |
| IECEX..... | IECEX KEM 09.0001X |
| c FM us..... | 3035277-C |
| INMETRO..... | NCC 12.1306 X |
| CCOE..... | P337349/6 |
| EAC Ex TR-CU 012/2011..... | RU C-DK.GB08.V.00410 |

Functional Safety:

SIL2 Certified & Fully Assessed acc. to IEC 61508

Visualisation in 4501 of hardware / software error

| Readout at hardware error: | | |
|------------------------------------|---------|---|
| Error search | Readout | Cause |
| Communications test 4501 / 9203 | NO.CO | Connection error |
| EEProm error - check configuration | FL.ER | Configuration error or crc mismatch, recovery configuration is loaded |
| Hardware error | DE.ER | Invalid recovery configuration in device |
| Hardware error | FC.ER | Invalid code checksum in 4501 |
| EEProm error - check configuration | CO.ER | Invalid configuration (CRC or data) |
| Hardware error | CA.ER | Factory calibration error |
| Hardware error | HW.ER | HW setup - configuration mismatch |
| Hardware error | OC.ER | Main output controller communication error |
| Hardware error | MS.ER | Main internal supply out of bounds |
| Hardware error | MI.ER | Main initialisation selftest failed |
| Hardware error | MC.ER | Main flash or ram selftest failed |

CONNECTIONS

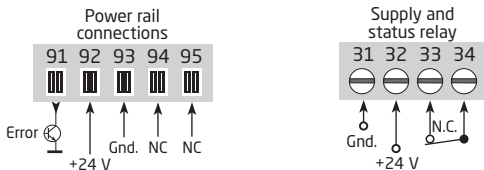

NC = No connection

INPUTS - 9203xxx:

Channel 1

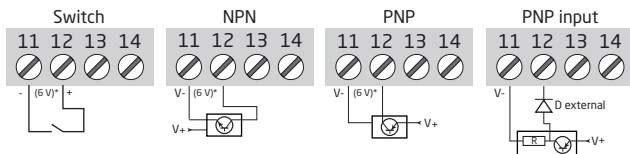

Channel 2

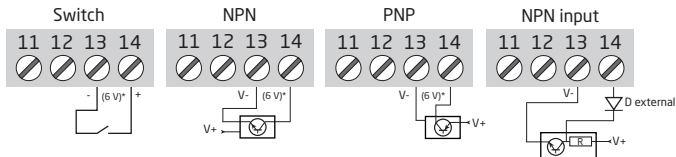

* 6 V at open state

INPUTS - 9203xxx1:

Channel 1

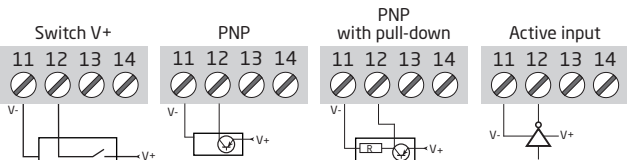

Channel 2

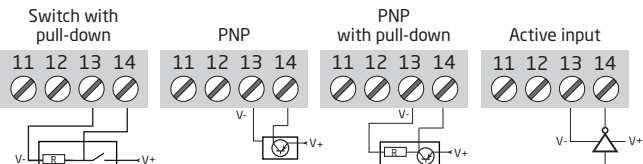

INPUTS - 9203xxx2:

Channel 1

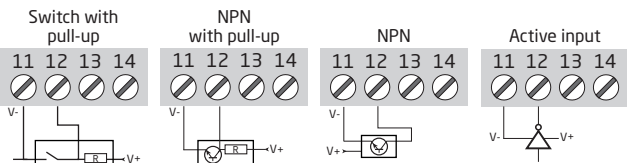

Channel 2

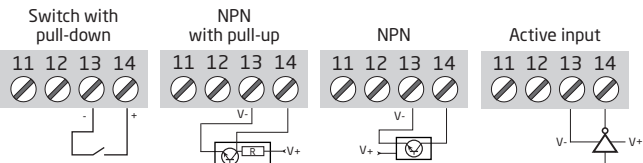

Outputs - 9203xxxx:

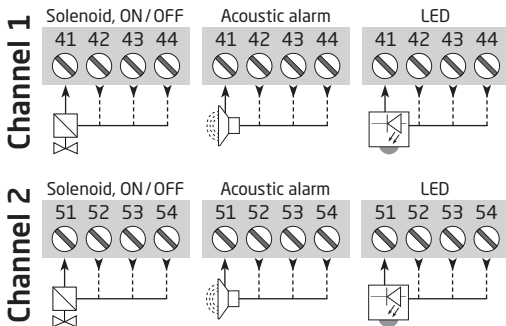

BLOCK DIAGRAM

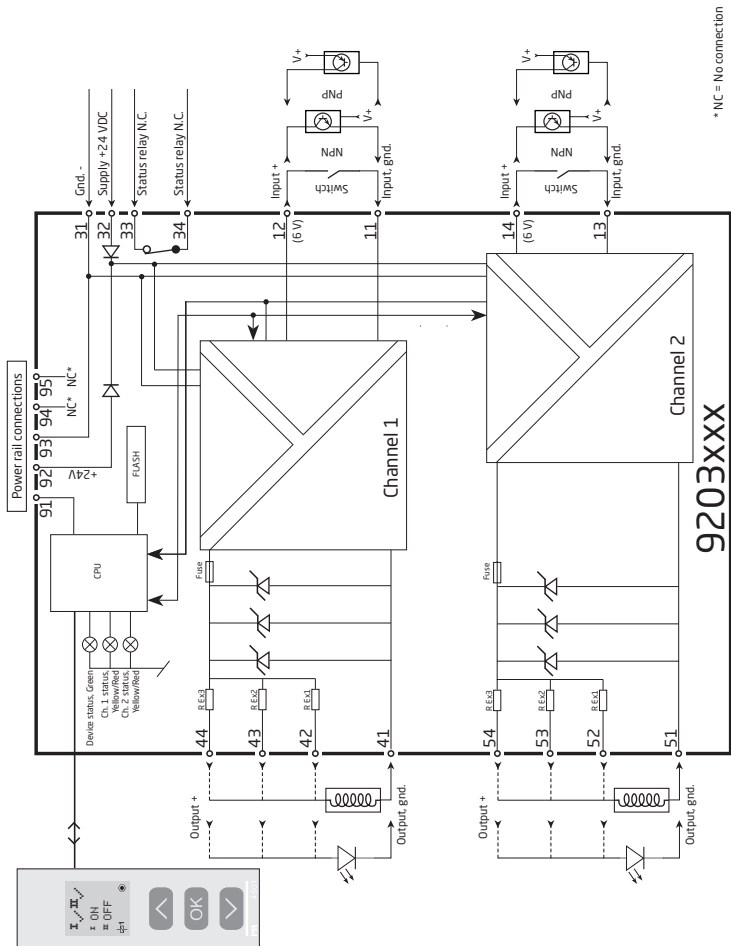

* NC = No connection

Signal error indications without display front

| LED and error signal indications | | | | | |
|----------------------------------|-----------|-----------------------|-----------------------|-----------------------|-----------------------------|
| State | Green LED | Ch 1: Yellow / Red | Ch 2: Yellow / Red | Status relay, N.C. | Power rail signal status |
| Device OK | Flashing | | | Energised | OFF |
| No supply | OFF | OFF | OFF | De-energised | ON |
| Device defective | OFF | Red | Red | De-energised | ON |
| | | | | | |
| Ch. 1, output ON | Flashing | Yellow | | Energised | OFF |
| Ch. 1, output OFF | Flashing | OFF | | Energised | OFF |
| | | | | | |
| Ch. 2, output ON | Flashing | | Yellow | Energised | OFF |
| Ch. 2, output OFF | Flashing | | OFF | Energised | OFF |

CONFIGURATION / OPERATING THE FUNCTION KEYS

Documentation for routing diagram.

In general

When configuring the 9203, you will be guided through all parameters and you can choose the settings which fit the application. For each menu there is a scrolling help text which is automatically shown in line 3 on the display.

Configuration is carried out by use of the 3 function keys:

- ⬆ will increase the numerical value or choose the next parameter
- ⬇ will decrease the numerical value or choose the previous parameter
- Ⓞ will accept the chosen value and proceed to the next menu

When configuration is completed, the display will return to the default state 1.0.

Pressing and holding Ⓞ will return to the previous menu or return to the default state (1.0) without saving the changed values or parameters.

If no key is activated for 1 minute, the display will return to the default state (1.0) without saving the changed values or parameters.

Further explanations

Password protection: Programming access can be blocked by assigning a password. The password is saved in the device in order to ensure a high degree of protection against unauthorised modifications to the configuration. Default password 2008 allows access to all configuration menus.

Signal and device error information via display front 4501

The display front can be configured to show output status, output current or tag no. for both channels. In case of hardware error, a help text explaining the error will be displayed.

Advanced functions

The unit gives access to a number of advanced functions which can be reached by answering "Yes" to the point "adv.set".

Display setup: Here you can adjust the brightness contrast and the backlight. Setup of TAG numbers with 5 alphanumeric. Selection of functional readout in line 2 and 3 of the display - choose between readout of output status, output current or tag no. When selecting "ALT" the readout toggles between the display options.

Password: Here you can choose a password between 0000 and 9999 in order to protect the device against unauthorised modifications to the configuration. The device is delivered default without password.

Language: In the menu "LANG" you can choose between 7 different language versions of help texts that will appear in the menu. You can choose between UK, DE, FR, IT, ES, SE and DK.

Safety Integrity Level (SIL): See Safety Manual for details.



ROUTING DIAGRAM

If no key is activated for 1 minute, the display will return to the default state 1.0 without saving configuration changes.

- ⊕ Increase value / choose next parameter
- ⊖ Decrease value / choose previous parameter
- ⊗ Accept the chosen value and proceed to the next menu
- Hold ⊗ Back to previous menu / return to menu 1.0 without saving

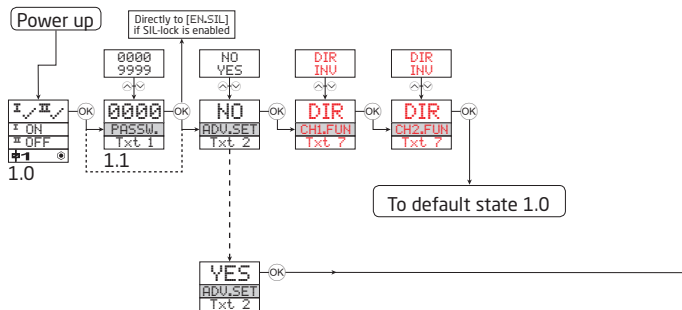

1.0 = Default state

Line 1 shows status for channel 1 and channel 2.

Line 2 shows output status for channel 1, output current or tag no.

Line 3 shows output status for channel 2, output current or tag no.

Line 4 indicates whether the device is SIL-locked.

1.1 = Only if password-protected.

1.2 = If password has been set.

Line 1 symbols:

⊕ = OK. Flashing ⊕ = error.

Line 2 and 3 symbols:

⊕ ON = channel 1 ON

⊕ OFF = channel 2 OFF.

Line 4 symbols:

Static dot = SIL-locked.

Flashing dot = Not SIL-locked.

⊕ = output is active.

Red text signifies safety parameters in a SIL configuration. See safety manual for details

ROUTING DIAGRAM, ADVANCED SETTINGS (ADV.SET)

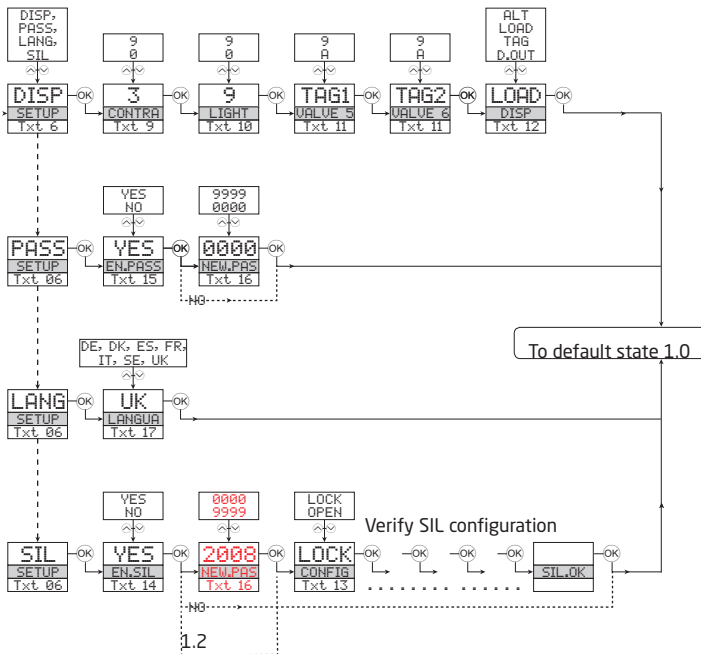

SCROLLING HELP TEXTS IN DISPLAY LINE 3

- [01] Set correct password
- [02] Enter advanced setup?
- [06] Enter language setup
Enter password setup
Enter display setup
Enter SIL setup
- [07] Select direct channel function
Select inverted channel function
- [09] Adjust LCD contrast
- [10] Adjust LCD backlight
- [11] Write a 5-character channel tag
- [12] Show output state in display
Show output load in display
Show tag in display
Alternate information shown in display
- [13] Configuration SIL status (Open / Locked)
- [14] Enable SIL configuration lock
- [15] Enable password protection?
- [16] Set new password
- [17] Select language
- [20] No communication - check connections
- [21] Eeprom error - check configuration
- [22] Hardware error

APPENDIX

IECEX INSTALLATION DRAWING

ATEX INSTALLATION DRAWING

FM INSTALLATION DRAWING

INMETRO INSTALLATION DRAWING

SAFETY MANUAL

IECEX Installation drawing



For safe installation of 9203 the following must be observed. The module shall only be installed by qualified personnel who are familiar with the national and international laws, directives and standards that apply to this area.

Year of manufacture can be taken from the first two digits in the serial number.



For Installation in Zone 2 / Division 2 the following must be observed.

The 4501 programming module is to be used solely with PRElectronics modules. It is important that the module is undamaged and has not been altered or modified in any way. Only 4501 modules free of dust and moisture shall be installed.

IECEX Certificate: IECEx KEM 09.0001X

Marking 9203Bxxx [Ex ia Ga] IIC/IIB/IIA
Ex nA nC IIC T4 Gc
[Ex ia Da] IIIC
[Ex ia Ma] I

Marking 9203Axxx Ex nA nC IIC T4 Gc

Standards IEC60079-15:2010, IEC60079-11:2011, IEC60079-0:2011

| Type | Installation | Current Output | Channels | Input |
|------|------------------------|-----------------|-----------|-------------|
| 9203 | Non Ex / Zone 2 :A | Low current :1 | Single :A | Standard :- |
| | | | Double :B | PNP :1 |
| | Ex-Barrier / Zone 2 :B | High current :2 | Single :A | NPN :2 |

Installation notes.

Install in pollution degree 2, overvoltage category II as defined in IEC60664-1

Do not separate connectors when energized and an explosive gas mixture is present.

Do not mount or remove modules from the Power Rail when an explosive gas mixture is present.

Disconnect power before servicing.

The wiring of unused terminals is not allowed.

In type of protection [Ex ia Da] the parameters for intrinsic safety for gas group IIB are applicable.

For installation in Zone 2, the module shall be installed in an enclosure in type of protection Ex n or Ex e, providing a degree of protection of at least IP54. Cable entry devices and blanking elements shall fulfill the same requirements.

For installation on Power Rail in Zone 2, only Power Rail type 9400 supplied by Power Control Unit type 9410 (IECEX Certificate of Conformity IECEx KEM 08.0025X) is allowed.

LERBAKKEN 10, 8410 RØNDE DENMARK

9203Bxxx Installation:

 Hazardous area
 Zone 0, 1, 2, 20, 21, 22

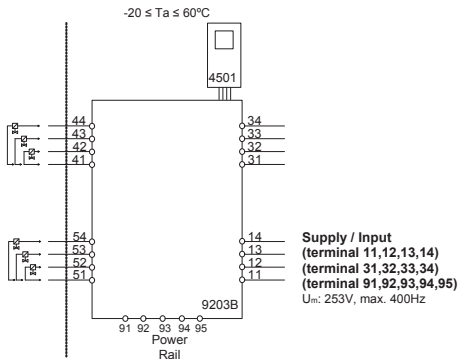
 Non Hazardous area
 or Zone 2

Terminal (31,32)
Supply:

 Voltage 19.2 – 31.2 VDC
 Power max. 3.5 W

Terminal (11,12 and 13,14)
Input:

 Voltage max 28 VDC
 Trig: NPN Low < 2 V, High > 4 V
 Trig: PNP Low < 8 V, High > 10 V

Terminal (33,34)
Status Relay:

 Voltage max. 125 VAC / 110 VDC
 Power max. 62.5 VA / 32 W
 Current max. 0.5 AAC / 0.3 ADC

Non Hazardous location
Zone 2 installation

 32 VAC / 32 VDC
 16 VA / 32 W
 0.5 AAC / 1 ADC

LERBAKKEN 10, 8410 RØNDE DENMARK

| | | | | | | | | | | | |
|--|-------|-----|--------|--------|---------|---------------------------|-------|-----|--------|--------|---------|
| 9203B1A, 9203B1B Terminal 41-42/51-52 | | | Co | Lo | Lo/Ro | 9203B2A Terminal 41-42 | | | Co | Lo | Lo/Ro |
| U _o | 28V | IIC | 80nF | 4.2mH | 54μH/Ω | U _o | 28V | IIC | 80nF | 2.69mH | 44μH/Ω |
| I _o | 93 mA | IIB | 640nF | 16.8mH | 218μH/Ω | I _o | 115mA | IIB | 640nF | 10.8mH | 176μH/Ω |
| P _o | 0.65W | IIA | 2.1μF | 32.6mH | 436μH/Ω | P _o | 0.81W | IIA | 2.1μF | 20.8mH | 353μH/Ω |
| | | I | 3.76μF | 32.6mH | 436μH/Ω | | | I | 3.76μF | 20.8mH | 353μH/Ω |
| | | | | | | | | | | | |
| 9203B1A, 9203B1B Terminal 41-43/51-53 | | | Co | Lo | Lo/Ro | 9203B2A Terminal 41-43 | | | Co | Lo | Lo/Ro |
| U _o | 28V | IIC | 80nF | 3.5mH | 54μH/Ω | U _o | 28V | IIC | | | |
| I _o | 100mA | IIB | 640nF | 14.2mH | 218μH/Ω | I _o | 125mA | IIB | 640nF | 9.1mH | 163μH/Ω |
| P _o | 0.70W | IIA | 2.1μF | 27.6mH | 436μH/Ω | P _o | 0.88W | IIA | 2.1μF | 17.6mH | 327μH/Ω |
| | | I | 3.76μF | 27.6mH | 436μH/Ω | | | I | 3.76μF | 17.6mH | 327μH/Ω |
| | | | | | | | | | | | |
| 9203B1A, 9203B1B Terminal 41-44/51-54 | | | Co | Lo | Lo/Ro | 9203B2A Terminal 41-44 | | | Co | Lo | Lo/Ro |
| U _o | 28V | IIC | 80nF | 2.9mH | 46μH/Ω | U _o | 28V | IIC | | | |
| I _o | 110mA | IIB | 640nF | 11.8mH | 184μH/Ω | I _o | 135mA | IIB | 640nF | 7.8mH | 150μH/Ω |
| P _o | 0.77W | IIA | 2.1μF | 22.8mH | 369μH/Ω | P _o | 0.95W | IIA | 2.1μF | 15.1mH | 301μH/Ω |
| | | I | 3.76μF | 22.8mH | 369μH/Ω | | | I | 3.76μF | 15.1mH | 301μH/Ω |

LERBAKKEN 10, 8410 RØNDE DENMARK

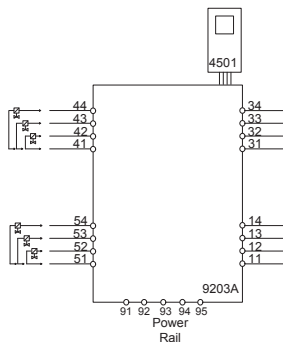
 9203Axxx Installation
 Non Classified area or Zone 2

Terminal (31,32)
Supply:

 Voltage 19.2 – 31.2 VDC
 Power max. 3.5 W

Terminal (11,12 and 13,14)
Input:

 Voltage max 28 VDC
 Trig: NPN Low < 2 V, High > 4 V
 Trig: PNP Low < 8 V, High > 10 V

Terminal (33,34)
Status Relay:
Non Hazardous location
 Voltage max. 125 VAC / 110 VDC
 Power max. 62.5 VA / 32 W
 Current max. 0.5 AAC / 0.3 ADC

Zone 2 installation

 32 VAC / 32 VDC
 16 VA / 32 W
 0.5 AAC / 1 ADC

Terminal (41...44 / 51...54)

 Umax 28 V
 Imax 135 mA
 Pmax 0.95 W

LERBAKKEN 10, 8410 RØNDE DENMARK

ATEX Installation drawing



For safe installation of 9203 the following must be observed. The module shall only be installed by qualified personnel who are familiar with the national and international laws, directives and standards that apply to this area.

Year of manufacture can be taken from the first two digits in the serial number.



For installation in Zone 2 / Division 2 the following must be observed. The 4501 programming module is to be used solely with PRelectronics modules. It is important that the module is undamaged and has not been altered or modified in any way. Only 4501 modules free of dust and moisture shall be installed.

ATEX Certificate KEMA 07ATEX 0147 X

Marking 9203B II (1) G [Ex ia Ga] IIC/IIB/IIA
 II 3G Ex nA nC IIC T4 Gc
 I (1) D [Ex ia Da] IIIC
 I (M1) [Ex ia Ma] I

Marking 9203A II 3G Ex nA nC IIC T4 Gc

Standards EN 60079-0 : 2012, EN 60079-11 : 2012, EN 60079-15 : 2010

| Type | Installation | Current Output | Channels | Input |
|------|---------------------------|----------------------|----------------|------------------|
| 9203 | Non Ex / Zone 2 :A | Low current :1 | Single :A | Standard :- |
| | | | Double :B | PNP : 1 |
| | Ex-Barrier / Zone 2 :B | High current :2 | Single :A | NPN : 2 |

Installation notes.

Install in pollution degree 2, overvoltage category II as defined in EN60664-1

Do not separate connectors when energized and an explosive gas mixture is present.
 Do not mount or remove modules from the Power Rail when an explosive gas mixture is present.
 Disconnect power before servicing.
 The wiring of unused terminals is not allowed.

In type of protection [Ex ia Da] the parameters for intrinsic safety for gas group IIB are applicable.

For installation in Zone 2, the module shall be installed in an enclosure in type of protection Ex n or Ex e, providing a degree of protection of at least IP54. Cable entry devices and blanking elements shall fulfill the same requirements.

For installation on Power Rail in Zone 2, only Power Rail type 9400 supplied by Power Control Unit type 9410 (Type Examination Certificate KEMA 07ATEX0152 X) is allowed.

LERBAKKEN 10, 8410 RØNDE DENMARK

9203Bxxx Installation:

Hazardous area
Zone 0,1,2, 20, 21, 22

Non Hazardous Area
or Zone 2

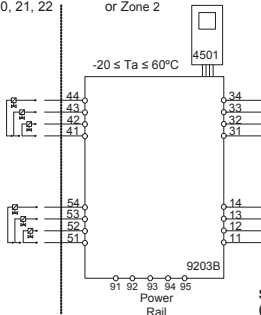

Supply / Input
(terminal 11,12,13,14)
(terminal 31,32,33,34)
(terminal 91,92,93,94,95)
Um: 253V, max. 400Hz

Terminal (31,32)

Supply:
Voltage 19.2 – 31.2 VDC
Power max. 3.5 W

Terminal (11,12 and 13,14)

Input:
Voltage max 28VDC
Trig: NPN Low < 2V, High > 4V
Trig: PNP Low < 8V, High > 10V

Terminal (33,34)

Status Relay: Non Hazardous location
Voltage max. 125 VAC / 110 VDC
Power max. 62.5 VA / 32 W
Current max. 0.5 AAC / 0.3 ADC

Zone 2 installation
32 VAC / 32 VDC
16 VA / 32 W
0.5 AAC / 1 ADC

LERBAKKEN 10, 8410 RØNDE DENMARK

| 9203B1A, 9203B1B Terminal 41-42/51-52 | | | Co | Lo | Lo/Ro | 9203B2A Terminal 41-42 | | | Co | Lo | Lo/Ro |
|--|-------|-----|--------|--------|---------|---------------------------|-------|-----|--------|--------|---------|
| U _o | 28V | IIC | 80nF | 4.2mH | 54μH/Ω | U _o | 28V | IIC | 80nF | 2.69mH | 44μH/Ω |
| I _o | 93 mA | IIB | 640nF | 16.8mH | 218μH/Ω | I _o | 115mA | IIB | 640nF | 10.8mH | 176μH/Ω |
| P _o | 0.65W | IIA | 2.1μF | 32.6mH | 436μH/Ω | P _o | 0.81W | IIA | 2.1μF | 20.8mH | 353μH/Ω |
| | | I | 3.76μF | 32.6mH | 436μH/Ω | | | I | 3.76μF | 20.8mH | 353μH/Ω |
| | | | | | | | | | | | |
| 9203B1A, 9203B1B Terminal 41-43/51-53 | | | Co | Lo | Lo/Ro | 9203B2A Terminal 41-43 | | | Co | Lo | Lo/Ro |
| U _o | 28V | IIC | 80nF | 3.5mH | 54μH/Ω | U _o | 28V | IIC | | | |
| I _o | 100mA | IIB | 640nF | 14.2mH | 218μH/Ω | I _o | 125mA | IIB | 640nF | 9.1mH | 163μH/Ω |
| P _o | 0.70W | IIA | 2.1μF | 27.6mH | 436μH/Ω | P _o | 0.88W | IIA | 2.1μF | 17.6mH | 327μH/Ω |
| | | I | 3.76μF | 27.6mH | 436μH/Ω | | | I | 3.76μF | 17.6mH | 327μH/Ω |
| | | | | | | | | | | | |
| 9203B1A, 9203B1B Terminal 41-44/51-54 | | | Co | Lo | Lo/Ro | 9203B2A Terminal 41-44 | | | Co | Lo | Lo/Ro |
| U _o | 28V | IIC | 80nF | 2.9mH | 46μH/Ω | U _o | 28V | IIC | | | |
| I _o | 110mA | IIB | 640nF | 11.8mH | 184μH/Ω | I _o | 135mA | IIB | 640nF | 7.8mH | 150μH/Ω |
| P _o | 0.77W | IIA | 2.1μF | 22.8mH | 369μH/Ω | P _o | 0.95W | IIA | 2.1μF | 15.1mH | 301μH/Ω |
| | | I | 3.76μF | 22.8mH | 369μH/Ω | | | I | 3.76μF | 15.1mH | 301μH/Ω |

LERBAKKEN 10, 8410 RØNDE DENMARK

9203Axxx Installation:
Non Classified area or Zone 2

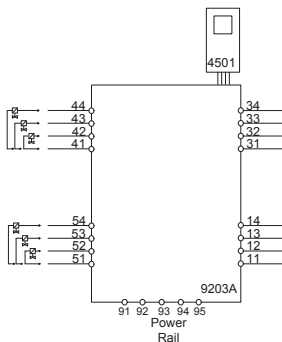

Terminal (31,32)

Supply:

Voltage 19.2 – 31.2 VDC
Power max. 3.5 W

Terminal (11,12 and 13,14)

Input:

Voltage max 28VDC
Trig: NPN Low < 2V, High > 4V
Trig: PNP Low < 8V, High > 10V

Terminal (33,34)

Status Relay:

Non Hazardous location
Voltage max. 125 VAC / 110 VDC
Power max. 62.5 VA / 32 W
Current max. 0.5 AAC / 0.3 ADC

Zone 2 installation

32 VAC / 32 VDC
16 VA / 32 W
0.5 AAC / 1 ADC

Terminal (41..44 / 51..54)

Umax 28 V
Imax 135 mA
Pmax 0.95 W

FM Installation drawing



For safe installation of 9203 the following must be observed. The module shall only be installed by qualified personnel who are familiar with the national and international laws, directives and standards that apply to this area.

Year of manufacture can be taken from the first two digits in the serial number.



For Installation in Zone 2 / Division 2 the following must be observed.

The 4501 programming module is to be used solely with PRelectronics modules. It is important that the module is undamaged and has not been altered or modified in any way. Only 4501 modules free of dust and moisture shall be installed.

c-FM-us Certificate 3035277

| Type | Installation | Current Output | Channels | Input | |
|------|---------------------|----------------|-----------------|-----------|-------------|
| 9203 | Non Ex / Zone 2 | :A | Low current :1 | Single :A | Standard :- |
| | | | High current :2 | Double :B | PNP :1 |
| | Ex-Barrier / Zone 2 | :B | High current :2 | Single :A | NPN :2 |
| | | | | | |

Installation notes:

The installation and wiring shall be in accordance with the Canadian Electrical Code for Canada and National Electrical Code NFPA 70, Article 500 or 505 for installation in USA.

The module must be supplied from a Power Supply having double or reinforced insulation.

The use of stranded wires is not permitted for mains wiring except when wires are fitted with cable ends.

For installation on the 9400 Power Rail the power must be supplied from Power Control Module Unit 9410.

Install in pollution degree 2, overvoltage category II.

The module must be installed in an enclosure suitable for the environment for which it is used.

For installation in Zone 2 or Division 2, the module must be installed in a suitable outer enclosure according to the regulations in the CEC for Canada or NEC for USA.

The module is galvanically isolated and does not require grounding.

Use 60 / 75 °C copper conductors with wire size AWG: (26-14).

The maximum internal Power dissipation for adjacent modules is assumed to be max. 2W each.

Warning: Substitution of components may impair intrinsic safety and / or suitability for Div. 2 / Zone 2.

Warning: To prevent ignition of explosive atmospheres, disconnect power before servicing and do not separate connectors when energized and an explosive gas mixture is present.

Warning: Do not mount or remove modules from the Power Rail when an explosive gas mixture is present.

LERBAKKEN 10, 8410 RØNDE DENMARK

9203Bxxx Installation:

Hazardous area

Class I/II/III, Division 1, Group A,B,C,D,E,F,G
or Class I, Zone 0/1 Group IIC, [AEx ia] IIC or
or Class I, Zone 0/1 Group IIC, [Ex ia] IIC

Non Hazardous Area or

Class I, Division 2, Group A,B,C,D T4
or Class I, Zone 2 Group IIC T4

Simple Apparatus or
Intrinsically safe apparatus
with entity parameters:

$V_{max}(U_i) \geq V_t(U_o)$
 $I_{max}(I_i) \geq I_t(I_o)$
 $P_i \geq P_t(P_o)$
 $Ca(C_o) \geq C_{cable} + C_i$
 $La(L_o) \geq L_{cable} + L_i$

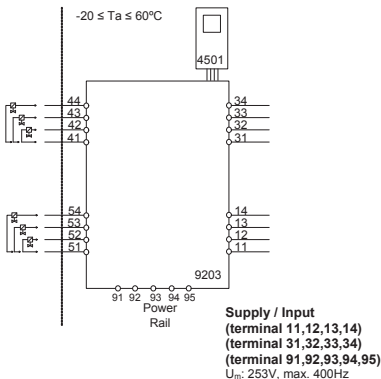

Terminal (31,32)

Supply:

Voltage 19.2 – 31.2 VDC
Power max. 3.5 W

Terminal (11,12 and 13,14)

Input:

Voltage max 28 VDC
Trig: NPN Low < 2 V, High > 4 V
Trig: PNP Low < 8 V, High > 10 V

Terminal (33,34)

Status Relay:

Voltage max. 125 VAC / 110 VDC
Power max. 62.5 VA / 32 W
Current max. 0.5 AAC / 0.3 ADC

Non Hazardous location:

Division 2 or Zone 2 installation:

32 VAC / 32VDC
16 VA / 32 W
0.5 AAC / 1 ADC

LERBAKKEN 10, 8410 RØNDE DENMARK

| Module 9203B1A & 9203B1B Terminal 41-42 / 51-52 | | | | Module 9203B2A Terminal 41-42 | | | | | |
|--|--------------|--------|---------|----------------------------------|--------|--------------|--------|---------|----------------|
| Uo/Voc | IIC or A.B | Co/Ca | Lo/La | Lo/Ro or La/Ra | Uo/Voc | IIC or A.B | Co/Ca | Lo/La | Lo/Ro or La/Ra |
| 28 V | IIC or A.B | 80 nF | 4.2 mH | 54 µH/Ω | 28 V | IIC or A.B | 80 nF | 2.69 mH | 44 µH/Ω |
| Ib/Isc | IIB or C.E.F | 640 nF | 16.8 mH | 218 µH/Ω | Ib/Isc | IIB or C.E.F | 640 nF | 10.8 mH | 176 µH/Ω |
| Po | IA or D.G | 2.1 µF | 32.6 mH | 436 µH/Ω | Po | IA or D.G | 2.1 µF | 20.8 mH | 353 µH/Ω |

| Module 9203B1A & 9203B1B Terminal 41-43 / 51-53 | | | | Module 9203B2A Terminal 41-43 | | | | | |
|--|--------------|--------|---------|----------------------------------|--------|--------------|--------|---------|----------------|
| Uo/Voc | IIC or A.B | Co/Ca | Lo/La | Lo/Ro or La/Ra | Uo/Voc | IIC or A.B | Co/Ca | Lo/La | Lo/Ro or La/Ra |
| 28 V | IIC or A.B | 80 nF | 3.5 mH | 50 µH/Ω | 28 V | IIC or A.B | 640 nF | 9.1 mH | 163 µH/Ω |
| Ib/Isc | IIB or C.E.F | 640 nF | 14.2 mH | 201 µH/Ω | Ib/Isc | IIB or C.E.F | 640 nF | 9.1 mH | 163 µH/Ω |
| Po | IA or D.G | 2.1 µF | 27.6 mH | 402 µH/Ω | Po | IA or D.G | 2.1 µF | 17.6 mH | 327 µH/Ω |

| Module 9203B1A & 9203B1B Terminal 41-44 / 51-54 | | | | Module 9203B2A Terminal 41-44 | | | | | |
|--|--------------|--------|---------|----------------------------------|--------|--------------|--------|---------|----------------|
| Uo/Voc | IIC or A.B | Co/Ca | Lo/La | Lo/Ro or La/Ra | Uo/Voc | IIC or A.B | Co/Ca | Lo/La | Lo/Ro or La/Ra |
| 28 V | IIC or A.B | 80 nF | 2.9 mH | 46 µH/Ω | 28 V | IIC or A.B | 640 nF | 7.8 mH | 150 µH/Ω |
| Ib/Isc | IIB or C.E.F | 640 nF | 11.8 mH | 184 µH/Ω | Ib/Isc | IIB or C.E.F | 640 nF | 7.8 mH | 150 µH/Ω |
| Po | IA or D.G | 2.1 µF | 22.8 mH | 369 µH/Ω | Po | IA or D.G | 2.1 µF | 15.1 mH | 301 µH/Ω |

9203Axxx Installation:

Non Classified area or Zone 2 or Division 2

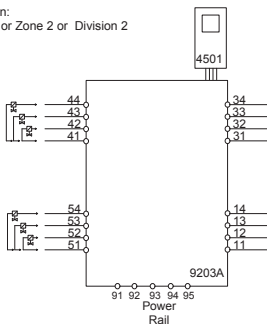
Terminal (31,32)
Supply:

 Voltage 19.2 – 31.2 VDC
 Power max. 3.5 W

Terminal (11,12 and 13,14)
Input:

 Voltage max 28 VDC
 Trig: NPN Low < 2 V, High > 4 V
 Trig: PNP Low < 8 V, High > 10 V

Terminal (33,34)
Status Relay:
Non Hazardous location
 Voltage max. 125 VAC / 110 VDC
 Power max. 62.5 VA / 32 W
 Current max. 0.5 AAC / 0.3 ADC

Zone 2 installation

 32 VAC / 32 VDC
 16 VA / 32 W
 0.5 AAC / 1 ADC

 Revision date:
 2015-01-22

 Version Revision
 V6R0

 Prepared by:
 PB

 Page:
 3/3

INMETRO Desenhos para Instalação



Para instalação segura do 9203B o manual seguinte deve ser observado. O módulo deve ser instalado somente por profissionais qualificados que estão familiarizados com as leis nacionais e internacionais, diretrizes e normas que se aplicam a esta área.
Ano de fabricação pode ser obtido a partir dos dois primeiros dígitos do número de série.



4501

Para a instalação na Zona 2 o seguinte deve ser observado. O módulo de programação de 4501, deve ser utilizado apenas com os módulos PRelectronics. É importante que o módulo esteja intacto e não tenha sido alterado ou modificado de qualquer maneira. Apenas os módulos 4501 livres de poeira e umidade devem ser instalados.

INMETRO Certificado NCC 12.1306X

Marcas

[Ex ia Ga] IIC/IIB/IIA
Ex nA nC IIC T4 Gc
[Ex ia Da] IIIC

Normas

IEC60079-15:2005, IEC60079-11:2011, IEC60079-0:2011
IEC60079-26:2006

Notas de instalação:

Instalação em grau de poluição 2, categoria de sobretensão II conforme definido no IEC 60664-1
Não separe conectores quando energizado ou quando uma mistura de gás explosivo estiver presente.

Não monte ou remova módulos do trilho de alimentação quando uma mistura explosiva de gás estiver presente.

Desligue a alimentação antes da manutenção.

A fiação de terminais sem uso não é permitida.

A fonte de Loop e terminais de entrada de corrente para o mesmo canal não deve ser aplicada ao mesmo tempo.

Em tipo de proteção [Ex ia Da] os parâmetros para a segurança intrínseca para grupo de gás IIB são aplicáveis.

Para a instalação em Zona 2, o módulo deve ser instalado em um invólucro certificado conforme as normas da série ABNT NBR IEC 60079 que proporcione um grau de proteção de pelo menos IP54. Dispositivos de entrada de cabo e elementos de vedação devem cumprir com os mesmos requisitos.

Para a instalação de trilho de energia na Zona 2, apenas o trilho de alimentação Rail 9400 fornecido pela Unidade de Controle de Potência 9410 é permitido.

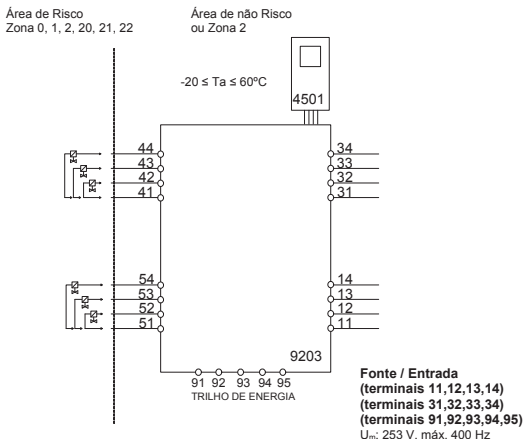

Terminal (31,32)

Fonte:

Voltagem 19,2 – 31,2 VDC
Potência máx. 3,5 W

Terminais (11,12 e 13,14)

Entrada:

Voltagem máx. 28,VDC
Gatilho: NPN Baixo < 2,V, Alto > 4,V
Gatilho: PNP Baixo < 8,V, Alto > 10,V

Terminais (33,34)

Relê de Estado:

Voltagem máx. 125 VAC / 110 VDC
Potência máx. 62,5 VA / 32 W
Corrente máx. 0,5 AAC / 0,3 ADC

Instalação Zona 2

32 VAC / 32 VDC
16 VA / 32 W
0,5 AAC / 1 ADC

| | | | | | | | | | | | |
|---|-------|-----|-------|--------|---------|----------------------------|-------|-----|-------|--------|---------|
| 9203B1A, 9203B1B Terminais 41-42/51-52 | | | Co | Lo | Lo/Ro | 9203B2A Terminais 41-42 | | | Co | Lo | Lo/Ro |
| Uo | 28V | IIC | 80nF | 4.2mH | 54μH/Ω | Uo | 28V | IIC | 80nF | 2.69mH | 44μH/Ω |
| Io | 93 mA | IIB | 640nF | 16.8mH | 218μH/Ω | Io | 115mA | IIB | 640nF | 10.8mH | 176μH/Ω |
| Po | 0.65W | IIA | 2.1μF | 32.6mH | 436μH/Ω | Po | 0.81W | IIA | 2.1μF | 20.8mH | 353μH/Ω |
| | | | | | | | | | | | |
| 9203B1A, 9203B1B Terminais 41-43/51-53 | | | Co | Lo | Lo/Ro | 9203B2A Terminais 41-43 | | | Co | Lo | Lo/Ro |
| Uo | 28V | IIC | 80nF | 3.5mH | 50μH/Ω | Uo | 28V | IIC | | | |
| Io | 100mA | IIB | 640nF | 14.2mH | 201μH/Ω | Io | 125mA | IIB | 640nF | 9.1mH | 163μH/Ω |
| Po | 0.70W | IIA | 2.1μF | 27.6mH | 402μH/Ω | Po | 0.88W | IIA | 2.1μF | 17.6mH | 327μH/Ω |
| | | | | | | | | | | | |
| 9203B1A, 9203B1B Terminais 41-44/51-54 | | | Co | Lo | Lo/Ro | 9203B2A Terminais 41-44 | | | Co | Lo | Lo/Ro |
| Uo | 28V | IIC | 80nF | 2.9mH | 46μH/Ω | Uo | 28V | IIC | | | |
| Io | 110mA | IIB | 640nF | 11.8mH | 184μH/Ω | Io | 135mA | IIB | 640nF | 7.8mH | 150μH/Ω |
| Po | 0.77W | IIA | 2.1μF | 22.8mH | 369μH/Ω | Po | 0.95W | IIA | 2.1μF | 15.1mH | 301μH/Ω |

SAFETY MANUAL

SOLENOID / ALARM DRIVER

9203

This safety manual is valid for the following product versions:

9203-001

9203-002

9203-003

0. CONTENTS

| | |
|---|----|
| 1. Observed standards | 2 |
| 2. Acronyms and abbreviations | 2 |
| 3. Purpose of the product..... | 3 |
| 4. Assumptions and restrictions for use of the product | 3 |
| 4.1 Basic safety specifications | 3 |
| 4.2 Associated equipment | 3 |
| 4.2.1 Safety output | 3 |
| 4.2.2 Safety input | 3 |
| 4.3 Failure rates..... | 3 |
| 4.4 Safe parameterisation..... | 4 |
| 4.5 Installation in hazardous areas | 4 |
| 5. Functional specification of the safety functions..... | 4 |
| 6. Functional specification of the non-safety functions | 4 |
| 7. Safety parameters | 4 |
| 8. Hardware and software configuration..... | 5 |
| 9. Failure category..... | 5 |
| 10. Periodic proof test procedure | 5 |
| 11. Procedures to repair or replace the product | 5 |
| 12. Maintenance..... | 5 |
| 13. Documentation for routing diagram..... | 6 |
| 13.1 In general..... | 6 |
| 13.2 Further explanations..... | 6 |
| 13.2.1 Password protection..... | 6 |
| 13.4 Advanced functions..... | 6 |
| 13.4.1 Display setup..... | 7 |
| 13.4.2 Password..... | 7 |
| 13.4.3 Language | 7 |
| 13.4.4 Power rail | 7 |
| 13.4.5 Safety integrity level | 7 |
| 14 Safe parameterisation - user responsibility | 8 |
| 14.1 Safety-related configuration parameters..... | 8 |
| 14.2 Verification procedure | 8 |
| 14.2.1 If no password is set..... | 8 |
| 14.2.2 If password is set..... | 9 |
| 14.3 Functional test..... | 9 |
| 15. Fault reaction and restart condition..... | 9 |
| 16 User interface..... | 10 |
| 16.1 Scrolling help texts in display line 3..... | 10 |
| 16.3 Routing diagram - Advanced settings (ADV.SET) | 12 |
| 17 Connections diagram..... | 13 |

1. Observed standards

| Standard | Description |
|--------------------|---|
| IEC 61508 | Functional Safety of electrical / electronic / programmable electronic safety-related systems |
| IEC 61508-2:2000 | Part 2: Requirements for electrical / electronic / programmable electronic safety-related systems |
| IEC 61508-3:1998 | Part 3: Software requirements |
| IEC 61326-3-1:2008 | Immunity requirements for safety-related systems |

2. Acronyms and abbreviations

| Acronym / Abbreviation | Designation | Description |
|------------------------|---|---|
| Element | | Term defined by IEC 61508 as “part of a subsystem comprising a single component or any group of components that performs one or more element safety functions” |
| PFD | Probability of Failure on Demand | This is the likelihood of dangerous safety function failures occurring on demand. |
| PFH | Probability of dangerous Failure per Hour | The term “Probability” is misleading, as IEC 61508 defines a Rate. |
| SFF | Safe Failure Fraction | Safe Failure Fraction summarises the fraction of failures which lead to a safe state and the fraction of failures which will be detected by diagnostic measures and lead to a defined safety action. |
| SIF | Safety Integrity Function | Function that provides fault detection (to ensure the necessary safety integrity for the safety functions) |
| SIL | Safety Integrity Level | The international standard IEC 61508 specifies four discrete safety integrity levels (SIL 1 to SIL 4). Each level corresponds to a specific probability range regarding the failure of a safety function. |

3. Purpose of the product

The 9203Bxxx can be mounted in the safe area or in zone 2 / div. 2 and transmit signals to zone 0, 1, 2 and zone 20, 21, 22 including M1 mining / Class I/II/III, Div. 1, Gr. A-G. Ex driver for the control of ON / OFF solenoids, acoustic alarms and LEDs mounted in the hazardous area.

The 9203Axxx can be mounted in the safe area or zone 2 / div. 2 and transmit signals to non-hazardous area. Driver for the control of ON / OFF solenoids, acoustic alarms and LEDs mounted in safe area.

The 9203 is controlled by an NPN/PNP signal or a switch signal.

Monitoring of internal error events via the individual status relay and/or a collective electronic signal via the power rail.

The 9203 has been designed, developed and certified for use in SIL 2 applications according to the requirements of IEC 61508.

4. Assumptions and restrictions for use of the product

4.1 Basic safety specifications

| | |
|------------------------------------|----------------------------------|
| Operational temperature range..... | -20...+60°C |
| Storage temperature range..... | -20...+85°C |
| Power supply type, min..... | Double or reinforced |
| Supply voltage | 19.2...31.2 VDC |
| Mounting area | Zone 2 / Division 2 or safe area |
| Mounting environment | Pollution degree 2 or better |

4.2 Associated equipment

4.2.1 Safety output

The safety output shall be connected to the equipment with a minimum load of 10 KΩ

4.2.2 Safety input

The safety input signal frequency shall not be higher than 20 Hz, and the pulse length shall not be shorter than 25 ms.

4.3 Failure rates

The basic failure rates from the Siemens standard SN 29500 are used as the failure rate database.

Failure rates are constant, wear-out mechanisms are not included.

External power supply failure rates are not included.

4.4 Safe parameterisation

The user is responsible for verifying the correctness of the configuration parameters. (See section 14 Safe parameterisation - user responsibility). Manual override may not be used for safety applications.

4.5 Installation in hazardous areas

The IECex Installation drawing, ATEX Installation drawing, INMETRO Installation drawing and FM Installation drawing shall be followed if the products are installed in hazardous areas.

5. Functional specification of the safety functions

Driver for the control of ON / OFF solenoids, acoustic alarms and LEDs.

6. Functional specification of the non-safety functions

The status relay (terminal 33 and 34), error signal on power rail (terminal 91) and LED outputs are not suitable for use in any Safety Instrumented Function.

7. Safety parameters

| | 9203x1xx | 9203x2xx |
|---|-------------------|----------|
| Probability of dangerous Failure per Hour (PFH) | 4.30E-08 | 4.60E-08 |
| | Note ¹ | |
| Probability of failure on demand (PFD) - 1 year proof test interval | 2.73E-04 | 2.92E-04 |
| Proof test interval (10% of loop PFD) | 5 years | 4 years |
| Safe Failure Fraction | 91% | 91% |
| Demand response time | <10 ms | |
| Demand mode | High | |
| Demand rate | 1000 s | |
| Mean Time To Repair (MTTR) | 24 hours | |
| Diagnostic test interval | 10 seconds | |
| Hardware Fault Tolerance (HFT) | 0 | |
| Component Type | B | |
| SIL capability | SIL 2 | |
| Description of the "Safe State" | De-energised | |

Note¹: The 9203 contains no lifetime limiting components, therefore the PFH figures are valid for up to 12 years, according to IEC 61508.

8. Hardware and software configuration

All configurations of software and hardware versions are fixed from factory, and cannot be changed by end-user or reseller.

This manual only covers products labelled with the product version (or range of versions) specified on the front page.

9. Failure category

| Failure category | Failure rates (1/h) | |
|---------------------------|---------------------|----------|
| | 9203x1xx | 9203x2xx |
| Fail Safe Detected | 0.00E+00 | 0.00E+00 |
| Fail Safe Undetected | 4.77E-07 | 4.80E-07 |
| Fail Dangerous Detected | 0.00E+00 | 0.00E+00 |
| Fail Dangerous Undetected | 4.30E-08 | 4.60E-08 |

10. Periodic proof test procedure

| Step | Action |
|------|--|
| 1 | Bypass the safety PLC or take other appropriate action to avoid a false trip |
| 2 | Connect a simulator identical to the input setup |
| 3 | Perform an ON / OFF signal for each channel |
| 4 | Observe whether the output channel acts as expected |
| 5 | Restore the input terminals to full operation |
| 6 | Remove the bypass from the safety PLC or otherwise restore normal operation |

This test will detect approximately 95% of possible "du" (dangerous undetected) failures in the device. The proof test is equivalent to the functional test.

11. Procedures to repair or replace the product

Any failures that are detected and that compromise functional safety should be reported to the sales department at PR electronics A/S.

Repair of the device and replacement of circuit breakers must be done by PR electronics A/S only.

12. Maintenance

No maintenance required.

13. Documentation for routing diagram

The routing diagram is shown in section 16.2.

13.1 In general

When configuring the 9203, you will be guided through all parameters and you can choose the settings which fit the application. For each menu there is a scrolling help text which is automatically shown in line 3 on the display.

Configuration is carried out by use of the 3 function keys:

- ⬆ will increase the numerical value or choose the next parameter
- ⬇ will decrease the numerical value or choose the previous parameter
- Ⓞ will accept the chosen value and proceed to the next menu

When configuration is completed, the display will return to the default state 1.0.

Pressing and holding Ⓞ will return to the previous menu or return to the default state (1.0) without saving the changed values or parameters.

If no key is activated for 1 minute, the display will return to the default state (1.0) without saving the changed values or parameters.

13.2 Further explanations

13.2.1 Password protection

Access to the configuration can be blocked by assigning a password. The password is saved in the device in order to ensure a high degree of protection against unauthorised modifications to the configuration. Default password 2008 allows access to all configuration menus.

Password protection is mandatory in SIL applications.

13.4 Advanced functions

The unit gives access to a number of advanced functions which can be reached by answering "Yes" to the point "adv.set".

13.4.1 Display setup

Here you can adjust the brightness contrast and the backlight. Setup of tag numbers with 5 alphanumerics. Selection of functional readout in line 2 and 3 of the display - choose between readout of digital output or tag no. When selecting "ALT" the readout toggles between digital output and tag no.

13.4.2 Password

Here you can choose a password between 0000 and 9999 in order to protect the device against unauthorised modifications to the configuration. The device is delivered default without password.

13.4.3 Language

In the menu "LANG" you can choose between 7 different language versions of help texts that will appear in the menu. You can choose between UK, DE, FR, IT, ES, SE and DK.

13.4.4 Power rail

In the menu "RAIL" you can choose if errors in the device are transmitted to the central surveillance in the PR 9410 power control unit.

13.4.5 Safety integrity level

See Safe parameterisation - user responsibility

14 Safe parameterisation - user responsibility

14.1 Safety-related configuration parameters

| Parameters | Value | Description |
|------------|-----------|------------------------------------|
| CH1.FUN | DIR / INV | Direct / inverted channel function |
| CH2.FUN. | DIR / INV | Direct / inverted channel function |
| PASSW | 0 - 9999 | New password |

The above safety-related configuration parameters are marked in red text in the routing diagrams and must be verified by the user in a SIL-configuration.

14.2 Verification procedure

The verification is done using the display / programming front PR 4501 by following the procedure described below.

14.2.1 If no password is set

| | Action | Display shows |
|----|---|---------------------------------|
| 1 | Press OK | ADV.SET |
| 2 | Set (ADV.SET) to Yes and press OK | DISP SETUP |
| 3 | Step down to (SIL SETUP) and press OK | EN.SIL |
| 4 | Set (EN SIL) to YES and press OK | NEW.PASS |
| 5 | Set password to a number between 0 and 9999 and press OK (At this time the device starts operating in SIL mode with the entered configuration parameters!) | Verify⇒OPEN "briefly" ⇒LOCK* |
| 6 | Press OK to confirm verification of the OPEN-LOCK in the display | CH1.FUN |
| 7 | Verify Channel 1 function and press OK | CH2:FUN |
| 8 | Verify Channel 2 function and press OK | PASSW |
| 9 | Verify password and press OK | SIL.OK |
| 10 | Verify SIL and press OK | |

* Open is shown briefly in the display.

14.2.2 If password is set

| | Action | Display shows |
|----|---|---------------------------------|
| 1 | Press OK | PASSW |
| 2 | Enter password and press OK | ADV.SET |
| 3 | Set (ADV.SET) to Yes and press OK | DISP SETUP |
| 4 | Step down to (SIL SETUP) and press OK | EN.SIL |
| 5 | Set (EN SIL) to YES and press OK (At this time the device starts operating in SIL mode with the entered configuration parameters!) | Verify⇒OPEN "briefly" ⇒LOCK* |
| 6 | Press OK to confirm verification of the OPEN-LOCK in the display | CH1.FUN |
| 7 | Verify Channel 1 function and press OK | CH2:FUN |
| 8 | Verify Channel 2 function and press OK | PASSW |
| 9 | Verify password and press OK | SIL.OK |
| 10 | Verify SIL and press OK | |

* Open is shown briefly in the display

14.3 Functional test

The user is responsible for making a functional test after verification of safety parameters. The procedure for periodic proof test described in section 10 shall be used.

15. Fault reaction and restart condition

When the 9203 detects a fault the output will go to Safe State, in which the safety output will go to "de-energised".

For device faults there are 2 ways of bringing the device out of Safe State.

1. Power cycle the device.
2. Bring the device out of SIL mode (choose "NO" in the menu point "EN.SIL"), and set it back to SIL mode again (choose "YES" in the menu point "EN.SIL" and verify the configuration).

16 User interface

16.1 Scrolling help texts in display line 3

- [[01] Set correct password
- [02] Enter advanced setup?
- [06] Enter language setup
Enter password setup
Enter display setup
Enter SIL setup
- [07] Select direct channel function
Select inverted channel function
- [09] Adjust LCD contrast
- [10] Adjust LCD backlight
- [11] Write a 5-character channel tag
- [12] Show output state in display
Show output load in display
Show tag in display
Alternate information shown in display
- [13] Configuration SIL status (Open / Locked)
- [14] Enable SIL configuration lock
- [15] Enable password protection?
- [16] Set new password
- [17] Select language
- [20] No communication - check connections
- [21] EEprom error - check configuration
- [22] Hardware error

ROUTING DIAGRAM

If no key is activated for 1 minute, the display will return to the default state 1.0 without saving configuration changes.

- ⤴ Increase value / choose next parameter
- ⤵ Decrease value / choose previous parameter
- ⊗ Accept the chosen value and proceed to the next menu
- Hold ⊗ Back to previous menu / return to menu 1.0 without saving

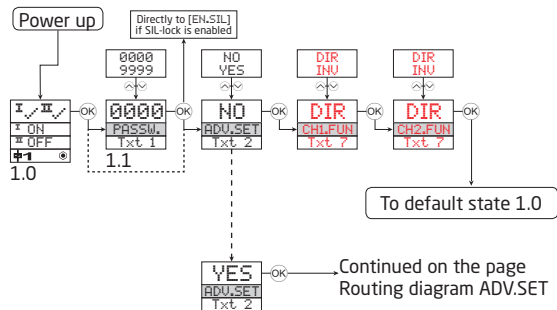

1.0 = Default state

Line 1 shows status for channel 1 and channel 2.

Line 2 shows output status for channel 1, output current or tag no.

Line 3 shows output status for channel 2, output current or tag no.

Line 4 indicates whether the module is SIL-locked.

1.1 = Only if password-protected.

1.2 If password has been set.

Line 1 symbols:

I ✓ = OK. Flashing II! = error.

Line 2 and 3 symbols:

I ON = channel 1 ON

II OFF = channel 2 OFF.

Line 4 symbols:

Static dot = SIL-locked.

Flashing dot = Not SIL-locked.

⚡ = output is active.

16.3 Routing diagram - Advanced settings (ADV.SET)

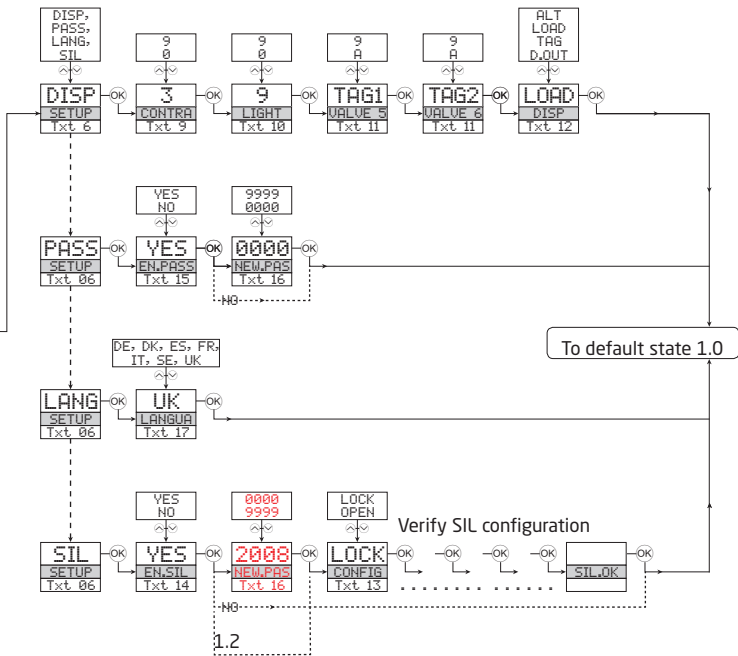

17 Connections diagram

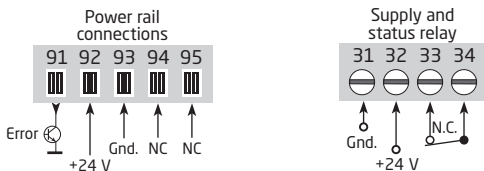

NC = No connection

INPUTS - 9203xxx:

Channel 1

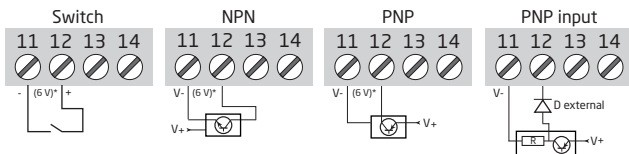

Channel 2

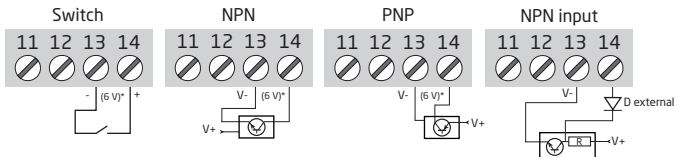

* 6 V at open state

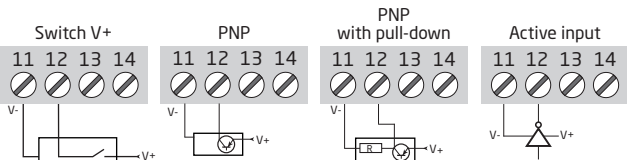
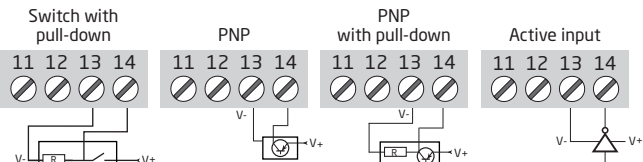
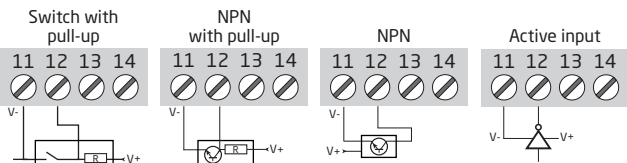
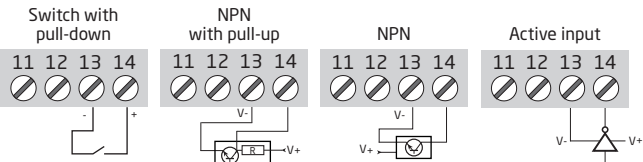
INPUTS - 9203xxx1:**Channel 1****Channel 2****INPUTS - 9203xxx2:****Channel 1****Channel 2**

Outputs - 9203xxxx:

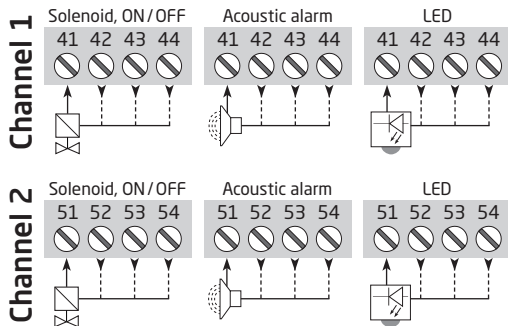



Displays Programmable displays with a wide selection of inputs and outputs for display of temperature, volume and weight, etc. Feature linearisation, scaling, and difference measurement functions for programming via PReset software.



Ex interfaces Interfaces for analogue and digital signals as well as HART® signals between sensors / I/P converters / frequency signals and control systems in Ex zone 0, 1 & 2 and for some devices in zone 20, 21 & 22.



Isolation Galvanic isolators for analogue and digital signals as well as HART® signals. A wide product range with both loop-powered and universal isolators featuring linearisation, inversion, and scaling of output signals.





























Temperature A wide selection of transmitters for DIN form B mounting and DIN rail devices with analogue and digital bus communication ranging from application-specific to universal transmitters.



Universal PC or front programmable devices with universal options for input, output and supply. This range offers a number of advanced features such as process calibration, linearisation and auto-diagnosis.



- 

www.preelectronics.fr

sales-fr@preelectronics.com
- 

www.preelectronics.de

sales-de@preelectronics.com
- 

www.preelectronics.es

sales-es@preelectronics.com
- 

www.preelectronics.it

sales-it@preelectronics.com
- 

www.preelectronics.se

sales-se@preelectronics.com
- 

www.preelectronics.com

sales-uk@preelectronics.com
- 

www.preelectronics.com

sales-us@preelectronics.com
- 

www.preelectronics.cn

sales-cn@preelectronics.com
- 

www.preelectronics.be

sales-be@preelectronics.com

Head office

Denmark
 PR electronics A/S
 Lerbakken 10
 DK-8410 Rønde

www.preelectronics.com
sales-dk@preelectronics.com
 tel. +45 86 37 26 77
 fax +45 86 37 30 85



QUALITY SYSTEM AND ENVIRONMENTAL MANAGEMENT SYSTEM
 DS/EN ISO 9001
 DS/EN ISO 14001

